

DATA SHEET

BLV910 UHF power transistor

Product specification

1995 Apr 11

Philips Semiconductors



PHILIPS

UHF power transistor

BLV910

FEATURES

- Internal input matching to achieve high power gain and easy design of wideband circuits
- Emitter ballasting resistors for an optimum temperature profile
- Gold metallization ensures excellent reliability.

APPLICATIONS

- Base station transmitters in the 820 to 960 MHz range.

PINNING - SOT171

PIN	SYMBOL	DESCRIPTION
1	e	emitter
2	e	emitter
3	b	base
4	c	collector
5	e	emitter
6	e	emitter

DESCRIPTION

NPN silicon planar epitaxial transistor intended for common emitter class-AB operation. The transistor is encapsulated in a 6-lead SOT171 flange envelope with a ceramic cap. All leads are isolated from the flange.

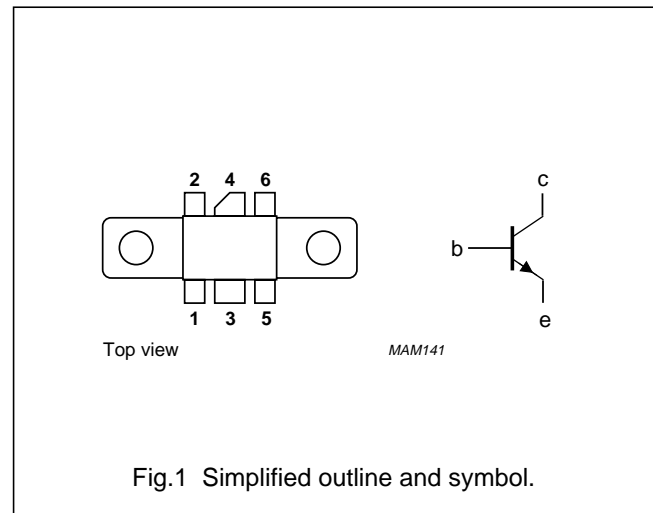

QUICK REFERENCE DATA

RF performance at $T_{mb} = 25\text{ }^\circ\text{C}$ in a common emitter test circuit.

MODE OF OPERATION	f (MHz)	V _{CE} (V)	P _L (W)	G _p (dB)	η_c (%)
CW, class-AB	960	26	10	≥ 11	≥ 55

WARNING

Product and environmental safety - toxic materials

This product contains beryllium oxide. The product is entirely safe provided that the BeO disc is not damaged. All persons who handle, use or dispose of this product should be aware of its nature and of the necessary safety precautions. After use, dispose of as chemical or special waste according to the regulations applying at the location of the user. It must never be thrown out with the general or domestic waste.

UHF power transistor

BLV910

LIMITING VALUES

In accordance with the Absolute Maximum Rating System (IEC 134).

SYMBOL	PARAMETER	CONDITIONS	MIN.	MAX.	UNIT
V_{CBO}	collector-base voltage	open emitter	–	70	V
V_{CEO}	collector-emitter voltage	open base	–	30	V
V_{EBO}	emitter-base voltage	open collector	–	3	V
I_C	collector current (DC)		–	1.5	A
$I_{C(AV)}$	average collector current		–	1.5	A
P_{tot}	total power dissipation	up to $T_{mb} = 25\text{ °C}$	–	30	W
T_{stg}	storage temperature		–65	+150	°C
T_j	operating junction temperature		–	200	°C

THERMAL CHARACTERISTICS

SYMBOL	PARAMETER	CONDITIONS	VALUE	UNIT
$R_{th\ j-mb}$	thermal resistance from junction to mounting base	$P_{tot} = 30\text{ W}; T_{mb} = 25\text{ °C}$	5.85	K/W
$R_{th\ mb-h}$	thermal resistance from mounting base to heatsink		0.4	K/W

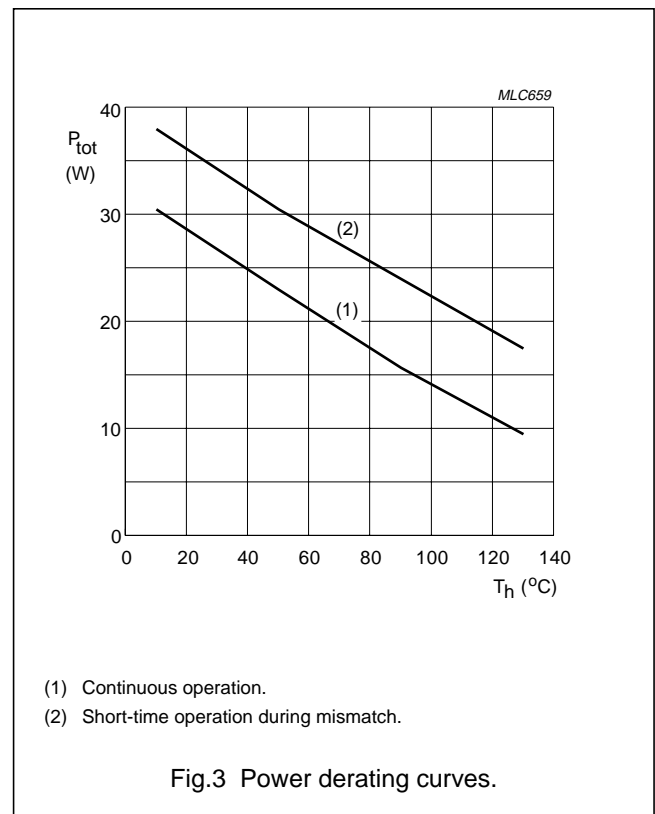
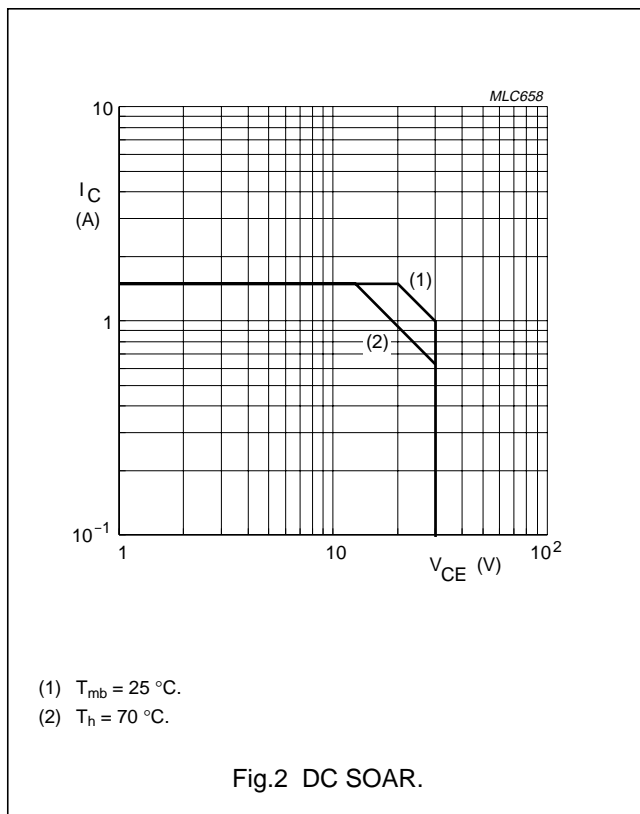

UHF power transistor

BLV910

CHARACTERISTICS

$T_j = 25\text{ }^\circ\text{C}$ unless otherwise specified.

SYMBOL	PARAMETER	CONDITIONS	MIN.	TYP.	MAX.	UNIT
$V_{(BR)CBO}$	collector-base breakdown voltage	open emitter; $I_C = 5\text{ mA}$	70	–	–	V
$V_{(BR)CEO}$	collector-emitter breakdown voltage	open base; $I_C = 15\text{ mA}$	30	–	–	V
$V_{(BR)EBO}$	emitter-base breakdown voltage	open collector; $I_E = 0.3\text{ mA}$	3	–	–	V
I_{CES}	collector leakage current	$V_{BE} = 0; V_{CE} = 28\text{ V}$	–	–	0.75	mA
h_{FE}	DC current gain	$V_{CE} = 10\text{ V}; I_C = 0.5\text{ A}$;	30	–	120	
C_c	collector capacitance	$V_{CB} = 26\text{ V}; I_E = i_e = 0; f = 1\text{ MHz}$	–	10	–	pF
C_{re}	feedback capacitance	$V_{CE} = 26\text{ V}; I_C = 0; f = 1\text{ MHz}$	–	6	–	pF

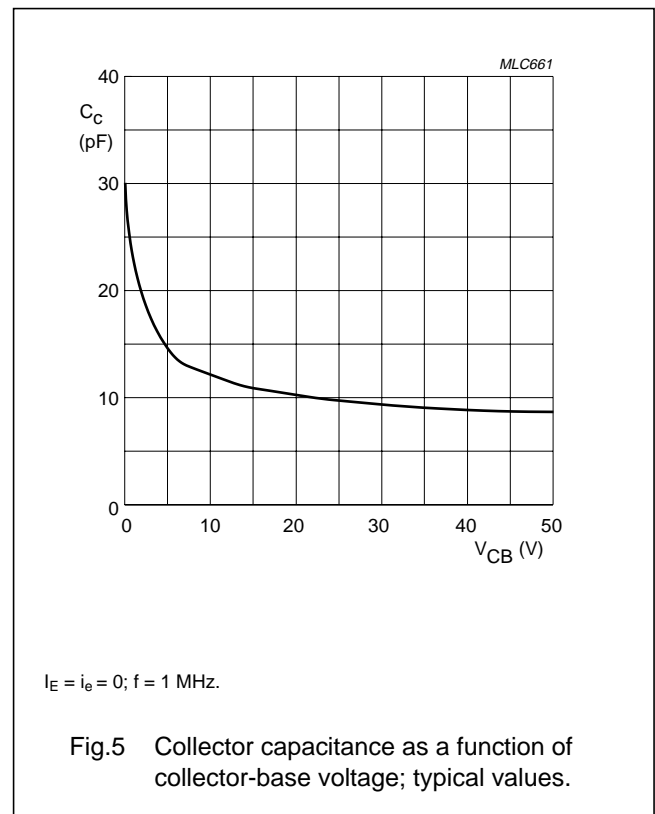
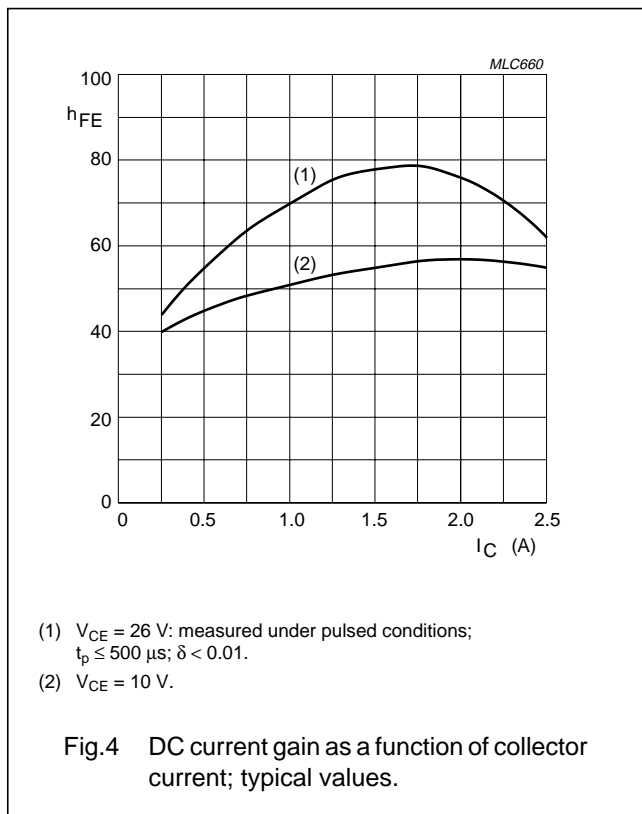

UHF power transistor

BLV910

APPLICATION INFORMATION

RF performance at $T_h = 25\text{ }^\circ\text{C}$ in a common emitter, class-AB test circuit.

MODE OF OPERATION	f (MHz)	V _{CE} (V)	I _{CQ} (mA)	P _L (W)	G _p (dB)	η _c (%)
CW, class-AB	960	26	25	10	≥11	≥55

Ruggedness in class-AB operation

The BLV910 is capable of withstanding a load mismatch corresponding to VSWR = 20 : 1 through all phases at rated output power, under the following conditions: V_{CE} = 26 V; f = 960 MHz; I_{CQ} = 25 mA; T_{mb} = 25 °C.

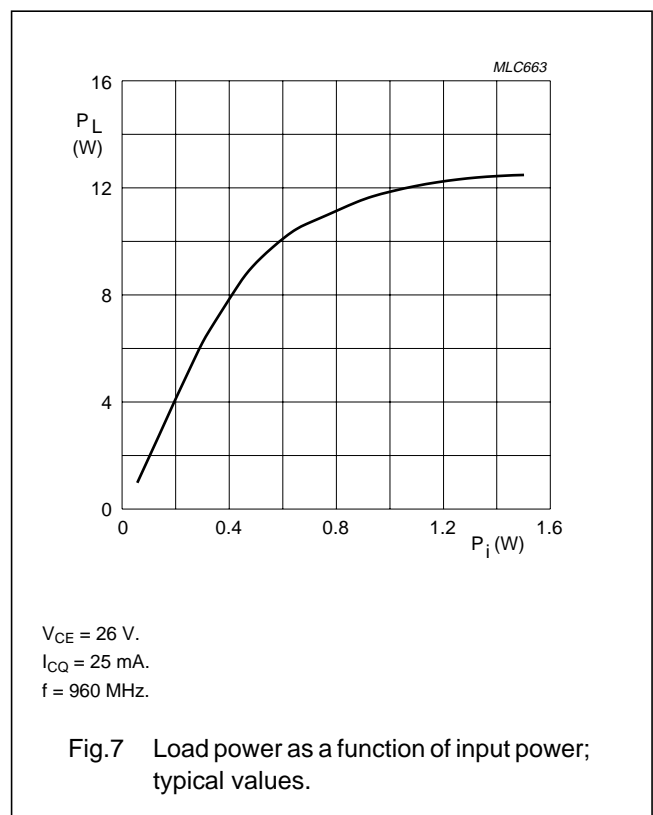
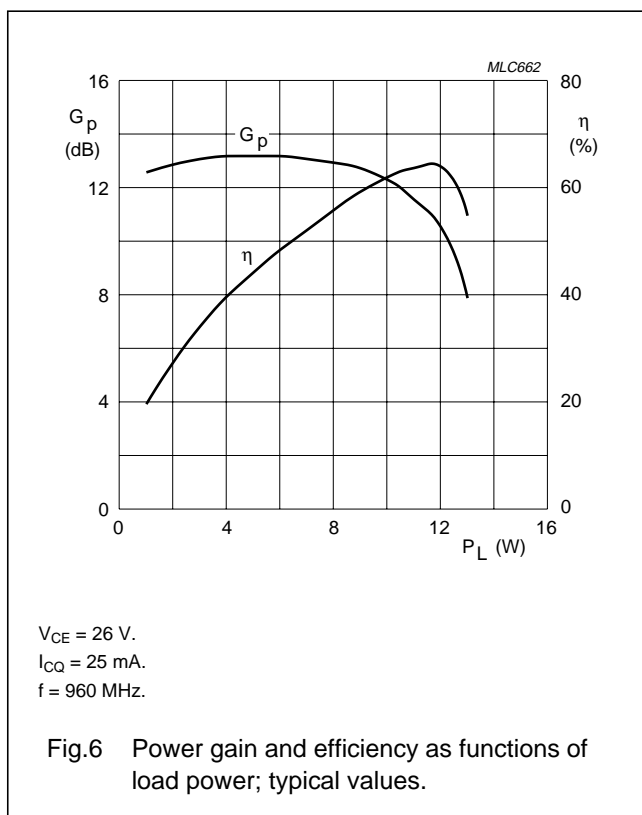

UHF power transistor

BLV910

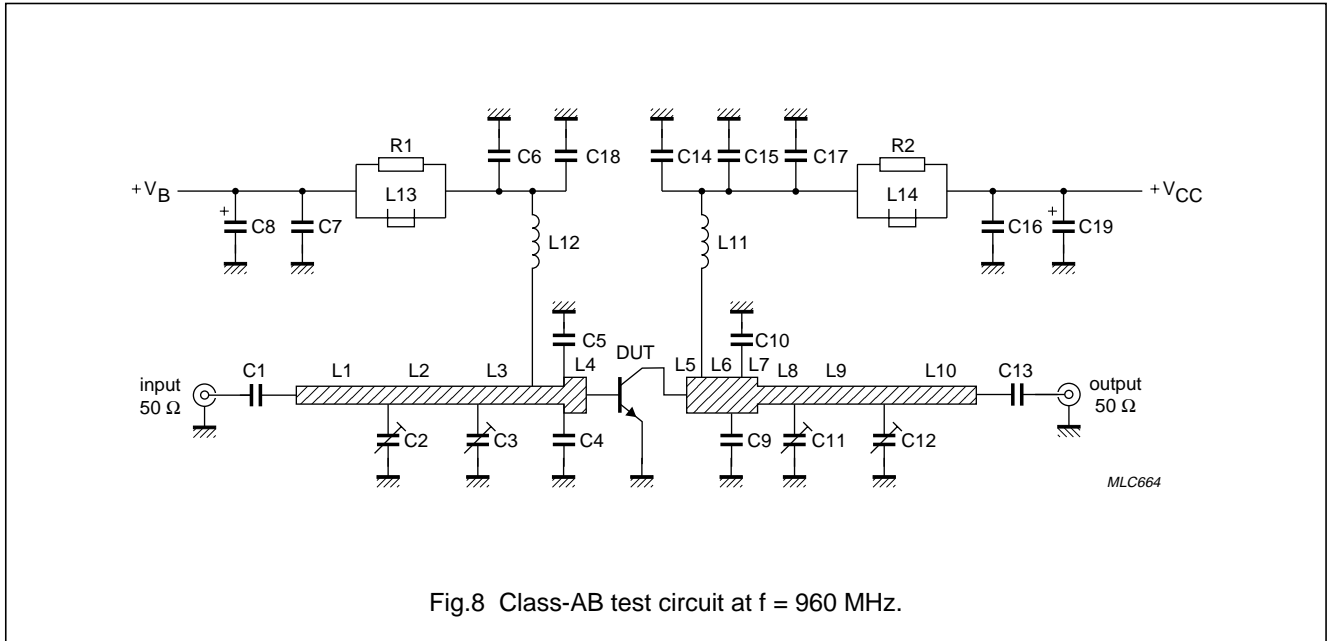

Fig.8 Class-AB test circuit at f = 960 MHz.

List of components (see Figs 8 and 9)

COMPONENT	DESCRIPTION	VALUE	DIMENSIONS	CATALOGUE No.
C1, C13	multilayer ceramic chip capacitor; note 1	43 pF		
C2, C3, C11, C12	film dielectric trimmer	1.4 pF to 5.5 pF		2222 809 09001
C4, C5	multilayer ceramic chip capacitor; note 2	10 pF		
C6	multilayer ceramic chip capacitor; note 1	150 pF		
C7, C16	ceramic capacitor	22 nF		2222 640 08223
C8, C19	solid aluminium capacitor	10 μF, 63 V		2222 030 38109
C14	multilayer ceramic chip capacitor; note 1	20 pF		
C9, C10	multilayer ceramic chip capacitor; note 2	8.2 pF		
C17	multilayer ceramic chip capacitor; note 1	220 pF		
C15, C18	multilayer ceramic chip capacitor; note 1	62 pF		
L1	stripline; note 3	50 Ω	length 17 mm width 2.4 mm	
L2, L3	stripline; note 3	50 Ω	length 14 mm width 2.4 mm	
L4	stripline; note 3	43 Ω	length 4 mm width 3 mm	

UHF power transistor

BLV910

COMPONENT	DESCRIPTION	VALUE	DIMENSIONS	CATALOGUE No.
L5, L6	stripline; note 3	43 Ω	length 3 mm width 3 mm	
L7	stripline; note 3	43 Ω	length 3.4 mm width 3 mm	
L8	stripline; note 3	50 Ω	length 6.3 mm width 2.4 mm	
L9	stripline; note 3	50 Ω	length 18 mm width 2.4 mm	
L10	stripline; note 3	50 Ω	length 15 mm width 2.4 mm	
L11	4 turns enamelled 0.8 mm copper wire		int. diameter 4mm length 5 mm leads 2 \times 5 mm	
L12	3 turns enamelled 0.8 mm copper wire		int. diameter 3mm length 5 mm leads 2 \times 5 mm	
L13, L14	grade 3B Ferroxcube wideband RF choke			4312 020 36642
R1, R2	metal film resistor	10 Ω , 0.4 W		2322 151 71009

Notes

1. American Technical Ceramics type 100B or capacitor of same quality.
2. American Technical Ceramics type 100A or capacitor of same quality.
3. The striplines are on double-clad PCB with PTFE fibre-glass dielectric ($\epsilon_r = 2.2$); thickness $\frac{1}{32}$ ".

UHF power transistor

BLV910

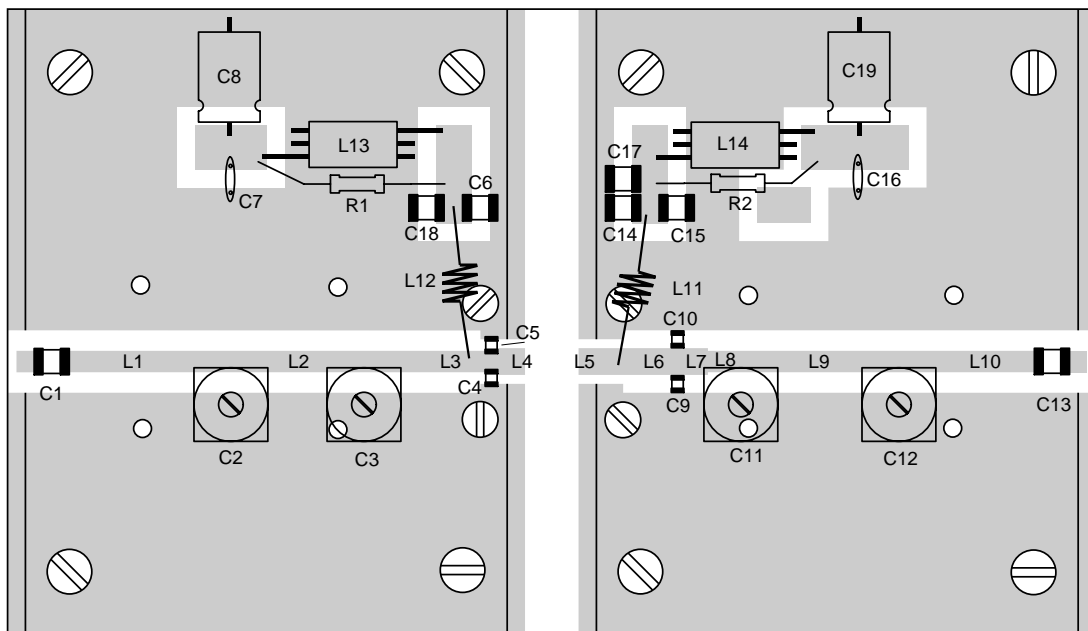
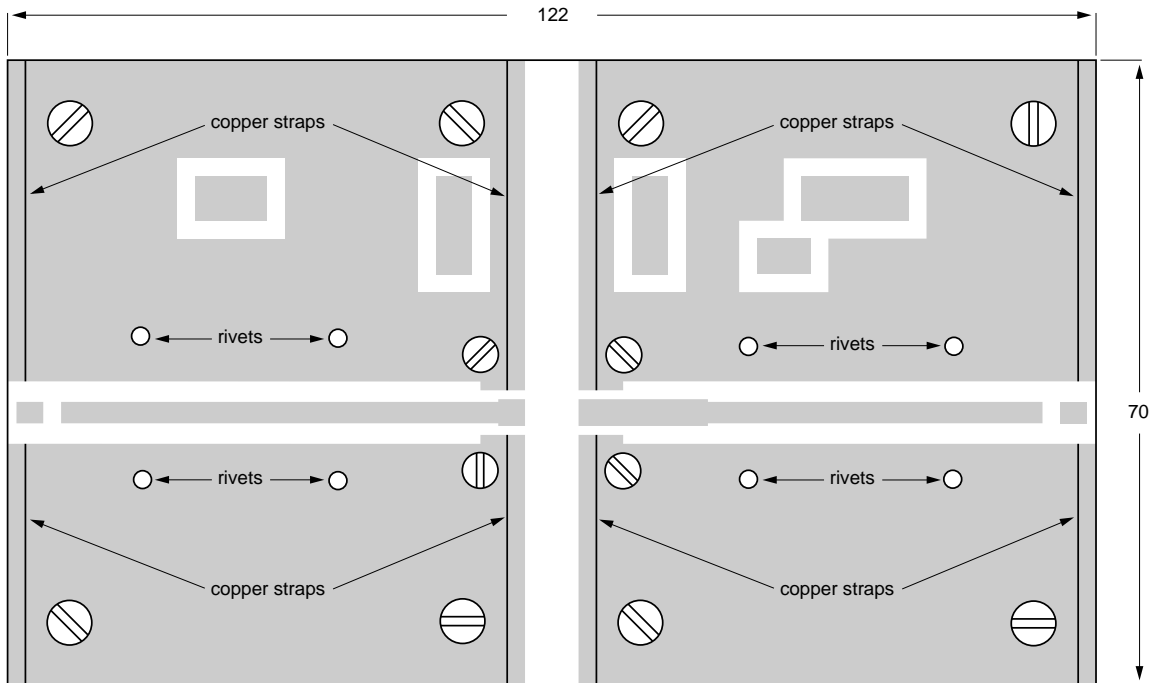

MLC665

Dimensions in mm.

The components are located on one side of the PTFE fibre-glass board, the other side being fully metallized to serve as an earth. Earth connections are made by fixing screws, hollow rivets and copper straps around the board and under the emitters to provide a direct contact between the component side and the ground plane.

Fig.9 Component layout for 960 MHz class-AB test circuit.

UHF power transistor

BLV910

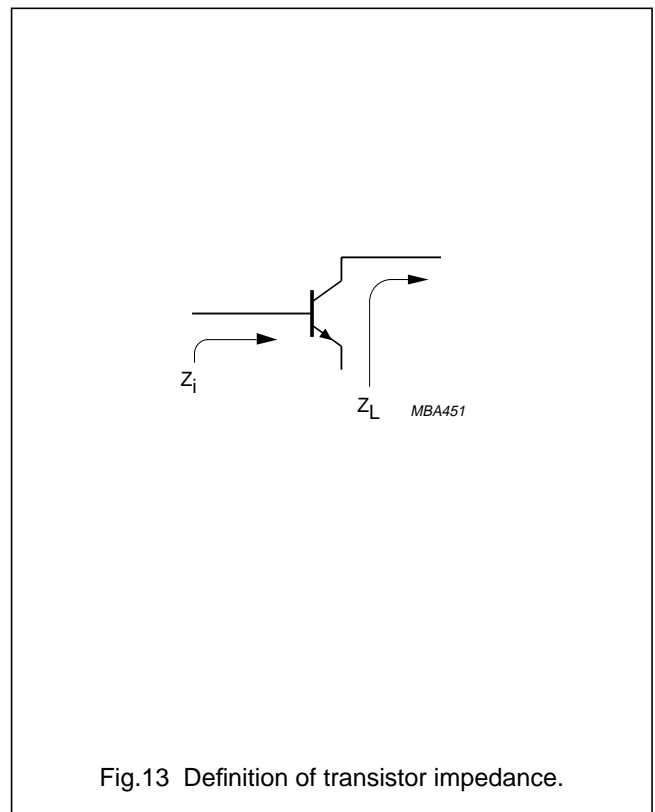
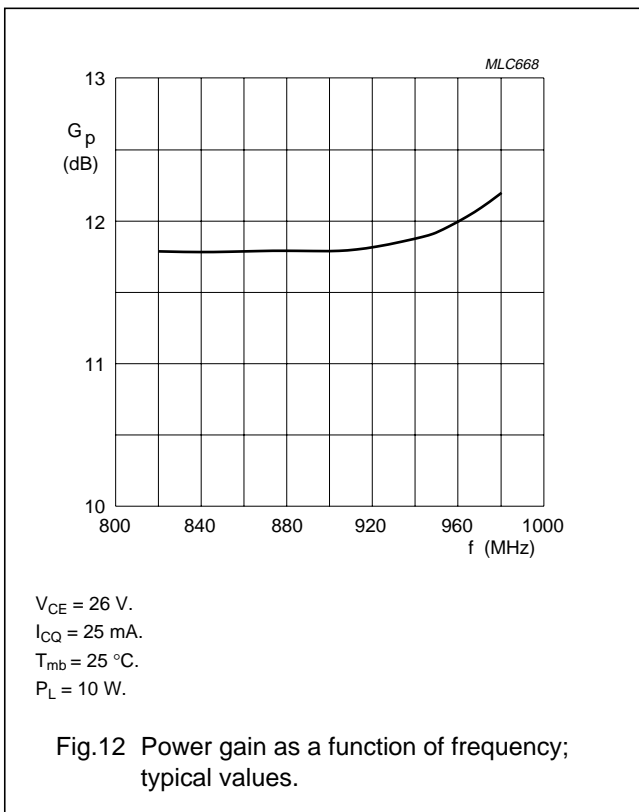
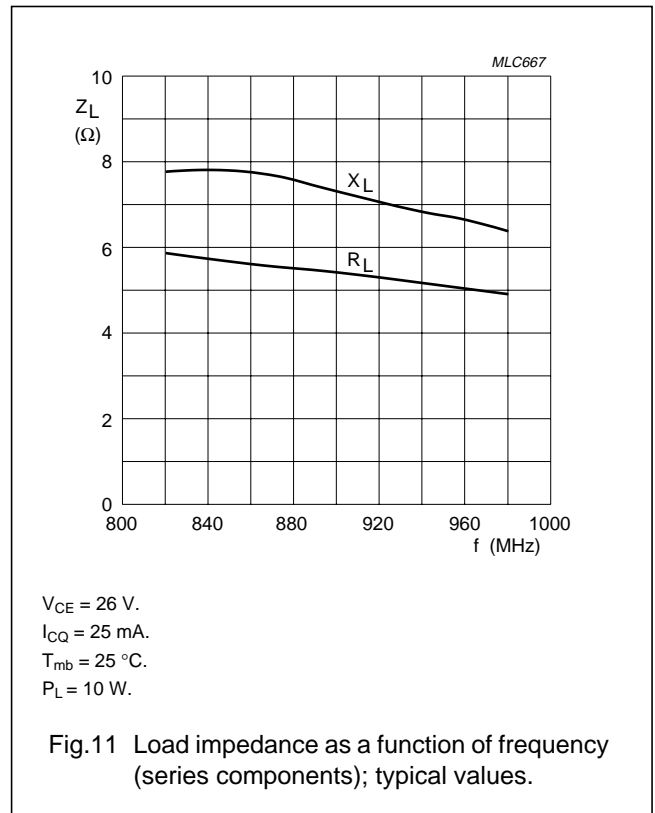
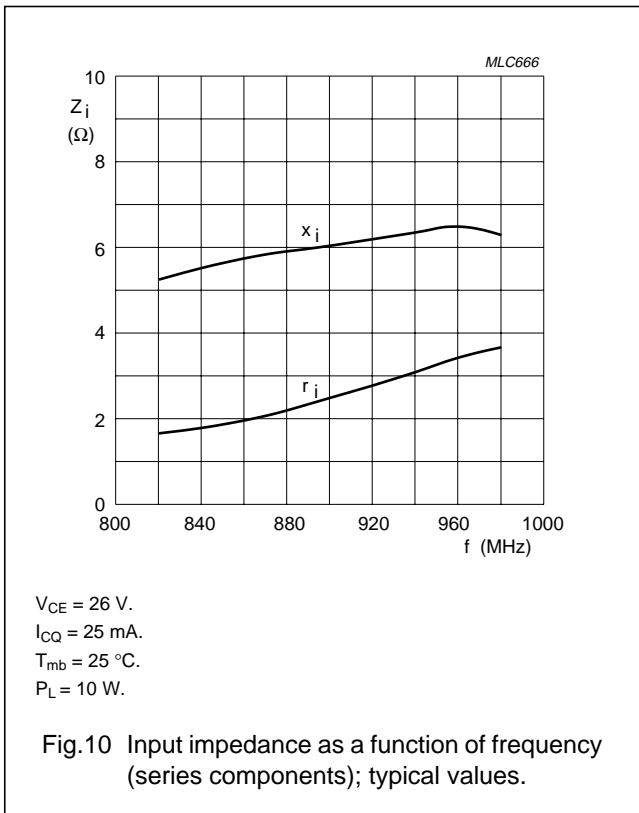

UHF power transistor

BLV910

PACKAGE OUTLINE

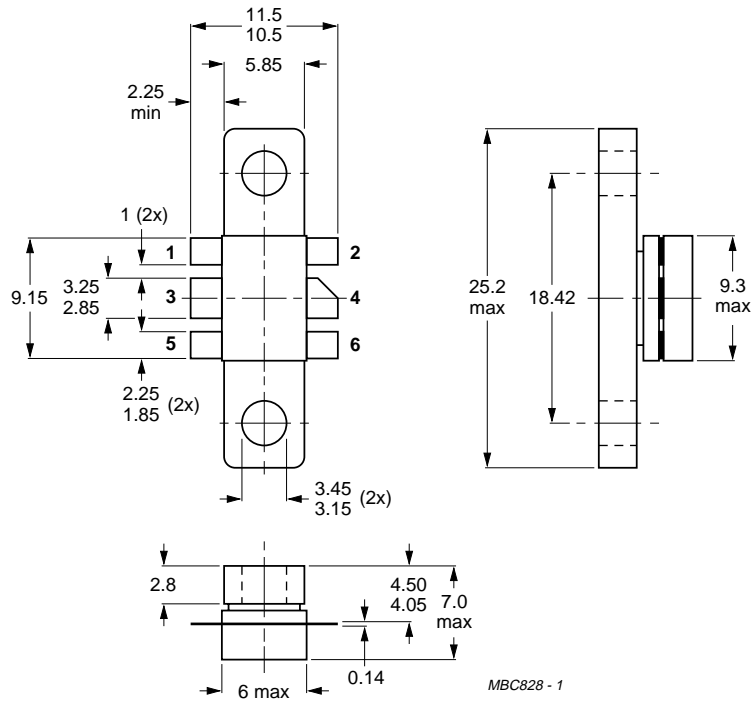

Dimensions in mm.

Torque on screw: min. 0.6 Nm; max. 0.75 Nm.

Recommended screw: cheese-head 4-40 UNC/2A.

Heatsink compound must be applied sparingly and evenly distributed.

Fig.14 SOT171.

UHF power transistor

BLV910

DEFINITIONS

Data Sheet Status	
Objective specification	This data sheet contains target or goal specifications for product development.
Preliminary specification	This data sheet contains preliminary data; supplementary data may be published later.
Product specification	This data sheet contains final product specifications.
Limiting values	
Limiting values given are in accordance with the Absolute Maximum Rating System (IEC 134). Stress above one or more of the limiting values may cause permanent damage to the device. These are stress ratings only and operation of the device at these or at any other conditions above those given in the Characteristics sections of the specification is not implied. Exposure to limiting values for extended periods may affect device reliability.	
Application information	
Where application information is given, it is advisory and does not form part of the specification.	

LIFE SUPPORT APPLICATIONS

These products are not designed for use in life support appliances, devices, or systems where malfunction of these products can reasonably be expected to result in personal injury. Philips customers using or selling these products for use in such applications do so at their own risk and agree to fully indemnify Philips for any damages resulting from such improper use or sale.

Philips Semiconductors – a worldwide company

Argentina: IEROD, Av. Juramento 1992 - 14.b, (1428)
BUENOS AIRES, Tel. (541)786 7633, Fax. (541)786 9367

Australia: 34 Waterloo Road, NORTH RYDE, NSW 2113,
Tel. (02)805 4455, Fax. (02)805 4466

Austria: Triester Str. 64, A-1101 WIEN, P.O. Box 213,
Tel. (01)60 101-1236, Fax. (01)60 101-1211

Belgium: Postbus 90050, 5600 PB EINDHOVEN, The Netherlands,
Tel. (31)40 783 749, Fax. (31)40 788 399

Brazil: Rua do Rocio 220 - 5th floor, Suite 51,
CEP: 04552-903-SÃO PAULO-SP, Brazil.
P.O. Box 7383 (01064-970).

Tel. (011)821-2333, Fax. (011)829-1849

Canada: PHILIPS SEMICONDUCTORS/COMPONENTS:
Tel. (800) 234-7381, Fax. (708) 296-8556

Chile: Av. Santa Maria 0760, SANTIAGO,
Tel. (02)773 816, Fax. (02)777 6730

Colombia: IPRELENZO LTDA, Carrera 21 No. 56-17,
77621 BOGOTA, Tel. (571)249 7624/(571)217 4609,
Fax. (571)217 4549

Denmark: Prags Boulevard 80, PB 1919, DK-2300 COPENHAGEN S,
Tel. (032)88 2636, Fax. (031)57 1949

Finland: Sinikalliontie 3, FIN-02630 ESPOO,
Tel. (9)0-50261, Fax. (9)0-520971

France: 4 Rue du Port-aux-Vins, BP317,
92156 SURESNES Cedex,
Tel. (01)4099 6161, Fax. (01)4099 6427

Germany: P.O. Box 10 63 23, 20043 HAMBURG,
Tel. (040)3296-0, Fax. (040)3296 213.

Greece: No. 15, 25th March Street, GR 17778 TAVROS,
Tel. (01)4894 339/4894 911, Fax. (01)4814 240

Hong Kong: PHILIPS HONG KONG Ltd., 15/F Philips Ind. Bldg.,
24-28 Kung Yip St., KWAI CHUNG, N.T.,
Tel. (852)424 5121, Fax. (852)480 6960/480 6009

India: Philips INDIA Ltd, Shivsagar Estate, A Block,
Dr. Annie Besant Rd. Worli, Bombay 400 018
Tel. (022)4938 541, Fax. (022)4938 722

Indonesia: Philips House, Jalan H.R. Rasuna Said Kav. 3-4,
P.O. Box 4252, JAKARTA 12950,
Tel. (021)5201 122, Fax. (021)5205 189

Ireland: Newstead, Clonskeagh, DUBLIN 14,
Tel. (01)640 000, Fax. (01)640 200

Italy: PHILIPS SEMICONDUCTORS S.r.l.,
Piazza IV Novembre 3, 20124 MILANO,
Tel. (0039)2 6752 2531, Fax. (0039)2 6752 2557

Japan: Philips Bldg 13-37, Kohnan2-chome, Minato-ku, TOKYO 108,
Tel. (03)3740 5028, Fax. (03)3740 0580

Korea: (Republic of) Philips House, 260-199 Itaewon-dong,
Yongsan-ku, SEOUL, Tel. (02)794-5011, Fax. (02)798-8022

Malaysia: No. 76 Jalan Universiti, 46200 PETALING JAYA,
SELANGOR, Tel. (03)750 5214, Fax. (03)757 4880

Mexico: 5900 Gateway East, Suite 200, EL PASO, TX 79905,
Tel. 9-5(800)234-7381, Fax. (708)296-8556

Netherlands: Postbus 90050, 5600 PB EINDHOVEN, Bldg. VB
Tel. (040)783749, Fax. (040)788399

New Zealand: 2 Wagener Place, C.P.O. Box 1041, AUCKLAND,
Tel. (09)849-4160, Fax. (09)849-7811

Norway: Box 1, Manglerud 0612, OSLO,
Tel. (022)74 8000, Fax. (022)74 8341

Pakistan: Philips Electrical Industries of Pakistan Ltd.,
Exchange Bldg. ST-2/A, Block 9, KDA Scheme 5, Clifton,
KARACHI 75600, Tel. (021)587 4641-49,
Fax. (021)577035/5874546.

Philippines: PHILIPS SEMICONDUCTORS PHILIPPINES Inc,
106 Valero St. Salcedo Village, P.O. Box 2108 MCC, MAKATI,
Metro MANILA, Tel. (02)810 0161, Fax. (02)817 3474

Portugal: PHILIPS PORTUGUESA, S.A.,
Rua dr. António Loureiro Borges 5, Arquiparque - Miraflores,
Apartado 300, 2795 LINDA-A-VELHA,
Tel. (01)4163160/4163333, Fax. (01)4163174/4163366.

Singapore: Lorong 1, Toa Payoh, SINGAPORE 1231,
Tel. (65)350 2000, Fax. (65)251 6500

South Africa: S.A. PHILIPS Pty Ltd.,
195-215 Main Road Martindale, 2092 JOHANNESBURG,
P.O. Box 7430 Johannesburg 2000,
Tel. (011)470-5911, Fax. (011)470-5494.

Spain: Balmes 22, 08007 BARCELONA,
Tel. (03)301 6312, Fax. (03)301 42 43

Sweden: Kottbygatan 7, Akalla. S-164 85 STOCKHOLM,
Tel. (0)8-632 2000, Fax. (0)8-632 2745

Switzerland: Allmendstrasse 140, CH-8027 ZÜRICH,
Tel. (01)488 2211, Fax. (01)481 77 30

Taiwan: PHILIPS TAIWAN Ltd., 23-30F, 66, Chung Hsiao West
Road, Sec. 1, Taipei, Taiwan ROC, P.O. Box 22978,
TAIPEI 100, Tel. (02)388 7666, Fax. (02)382 4382.

Thailand: PHILIPS ELECTRONICS (THAILAND) Ltd.,
209/2 Sanpavuth-Bangna Road Prakanong,
Bangkok 10260, THAILAND,
Tel. (662)398-0141, Fax. (662)398-3319.

Turkey: Talatpasa Cad. No. 5, 80640 GÜLTEPE/ISTANBUL,
Tel. (0212)279 27 70, Fax. (0212)282 67 07

United Kingdom: Philips Semiconductors LTD.,
276 Bath Road, Hayes, MIDDLESEX UB3 5BX,
Tel. (0181)730-5000, Fax. (0181)754-8421

United States: 811 East Arques Avenue, SUNNYVALE,
CA 94088-3409, Tel. (800)234-7381, Fax. (708)296-8556

Uruguay: Coronel Mora 433, MONTEVIDEO,
Tel. (02)70-4044, Fax. (02)92 0601

Internet: <http://www.semiconductors.philips.com/ps/>

For all other countries apply to: Philips Semiconductors,
International Marketing and Sales, Building BE-p,
P.O. Box 218, 5600 MD EINDHOVEN, The Netherlands,
Telex 35000 phtcnl, Fax. +31-40-724825

SCD38 © Philips Electronics N.V. 1995

All rights are reserved. Reproduction in whole or in part is prohibited without the prior written consent of the copyright owner.

The information presented in this document does not form part of any quotation or contract, is believed to be accurate and reliable and may be changed without notice. No liability will be accepted by the publisher for any consequence of its use. Publication thereof does not convey nor imply any license under patent- or other industrial or intellectual property rights.

Printed in The Netherlands

123052/1500/01/pp12
Document order number:

Date of release: 1995 Apr 11
9397 750 00072

Philips Semiconductors



PHILIPS